

Material

- Glazed titanium steel

Features

- with overflow hole
- with faucet hole bench
- overflow set (ABS) included



Colors

- C058 White matte
- C__ Color class III, IV, V, VI



➔ color list

Options

- FH2 3-hole faucet (4")
- FH3 3-hole faucet (8")
- CE1 CLEANEFFECT
- Custom round hole
- SDH2 Hole for Schmidlin built-in soap dispenser (Ø 1")
- OH0 Without overflow hole
- FH1 Single hole faucet
- FH0 without faucet hole

Accessories

- 109547 Schmidlin ELEMENT, magnetic candle holder
- 108242 Schmidlin ELEMENT, magnetic glass holder
- 108243 Schmidlin ELEMENT, magnetic soap dish
- 108241 Schmidlin ELEMENT, magnetic soap dispenser
- 111479 Schmidlin MAGNO magnetic soapdispenser white
- 111480 Schmidlin MAGNO magnetic soapdispenser, black matte
- 111482 Schmidlin MAGNO magnetic toothbrush holder, black matte
- 111481 Schmidlin MAGNO magnetic toothbrush holder, white
- 100534 Reinforcement flange for tap mounting
- 2378-0001 Schmidlin back- / side-splash
- 2376-0001 Schmidlin back- / side-splash
- 100530 Schmidlin soap dispenser

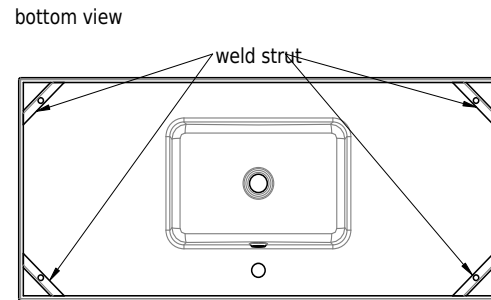
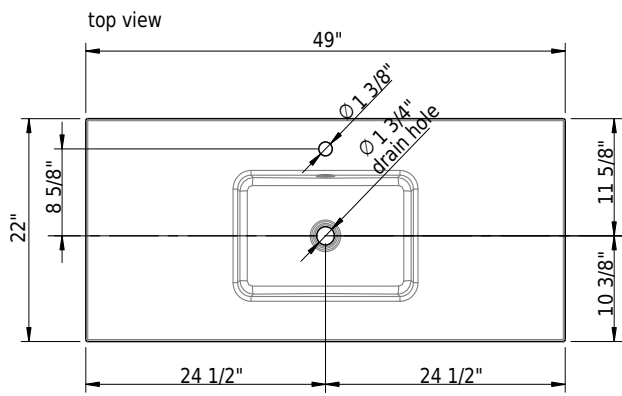
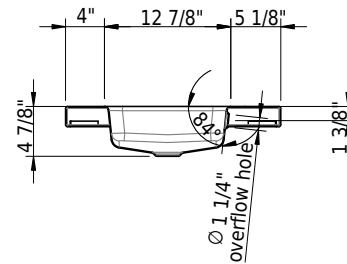
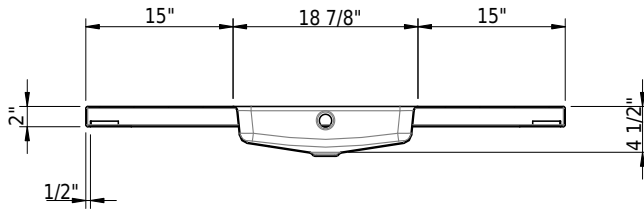

Technical Information

with faucet hole diameter	1 3/8"
Bowl configuration	single
Bowl depth	4 1/2"
Bowl size	18 7/8" x 12 7/8"
Water depth to overflow	2 1/2"
Drain hole diameter	1 3/4"



➤ Installation Instructions

Standards / Codes

- This product complies with
- ASME A112.19.1 / CSA B45.2
- ASTM F462

Notes

- Overflow-set included
- Drain and faucet not included
- Refer to installation instructions
- We recommend the use of Schmidlin reinforcement flange for faucet installation

Important: Dimensions of fixtures are nominal and may vary within the range tolerances established by ANSI standard A112.19.4. These measurements are subject to change or cancellation. No responsibility is assumed for use of superseded or voided leaflet.