

### Material

- Glazed titanium steel

### Features

- ANTIGLISS included
- Option made to measure

### Compatible drain fittings

- Geberit offset, ABS 151.602.21.1 (polished chrome)
- Geberit offset, PP 150.183.00.1 (rough-in unit)
- Geberit offset, brass 151.450.00.1 (rough-in unit)
- Mountain Plumbing offset, brass BDR20SBR22/FFF (cable drive)
- Mountain Plumbing offset, ABS BWO40S22A2/FFF (cable drive)
- Mountain Plumbing offset, PVC BWO40S22P2/FFF (cable drive)
- OS&B direct, brass 307DQ-25FFF (clicker)
- OS&B offset, PVC 5100QK-FFF (clicker)
- Jaco offset, brass 386-LT (cable-drive)
- Jaco offset, PVC 383-LT (cable-drive)

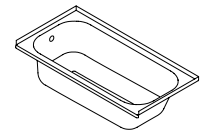

### Variant no

### Color

### Tile flange

<input type="checkbox"/> 2232-0002	C1 white gloss	TF00 no tile flange
<input type="checkbox"/> 2232-0003	C1 white gloss	TF01 Tile flange on 3 sides, drain left
<input type="checkbox"/> 2232-0004	C1 white gloss	TF02 Tile flange on 3 sides, drain right
<input type="checkbox"/> 2232-0005	C1 white gloss	TF03 Tile flanges left / back, drain left
<input type="checkbox"/> 2232-0006	C1 white gloss	TF04 Tile flanges right / back, drain right



### Colors

- C058 White matte
- C\_\_ Color class III,VI



➔ color list

### Accessories

- 109547 Schmidlin ELEMENT, magnetic candle holder
- 101187 Schmidlin RELAX bathtub pillow, black, 1 piece
- 117005 Schmidlin 2-corner tape-flange, 155" (4m)
- 109810 Schmidlin adjustable installation feet (4 pieces)
- 101196 Schmidlin mounting angle for tile flange (SIA 181), 4 pieces

### Options

- CE1 CLEANEFFECT
- HC2 Handle CONTURA
- HS2 Handle SAFE
- Special length / width -1"/+2"
- TF\_\_ Tile flange

06/18/2026 Subject to technical changes.

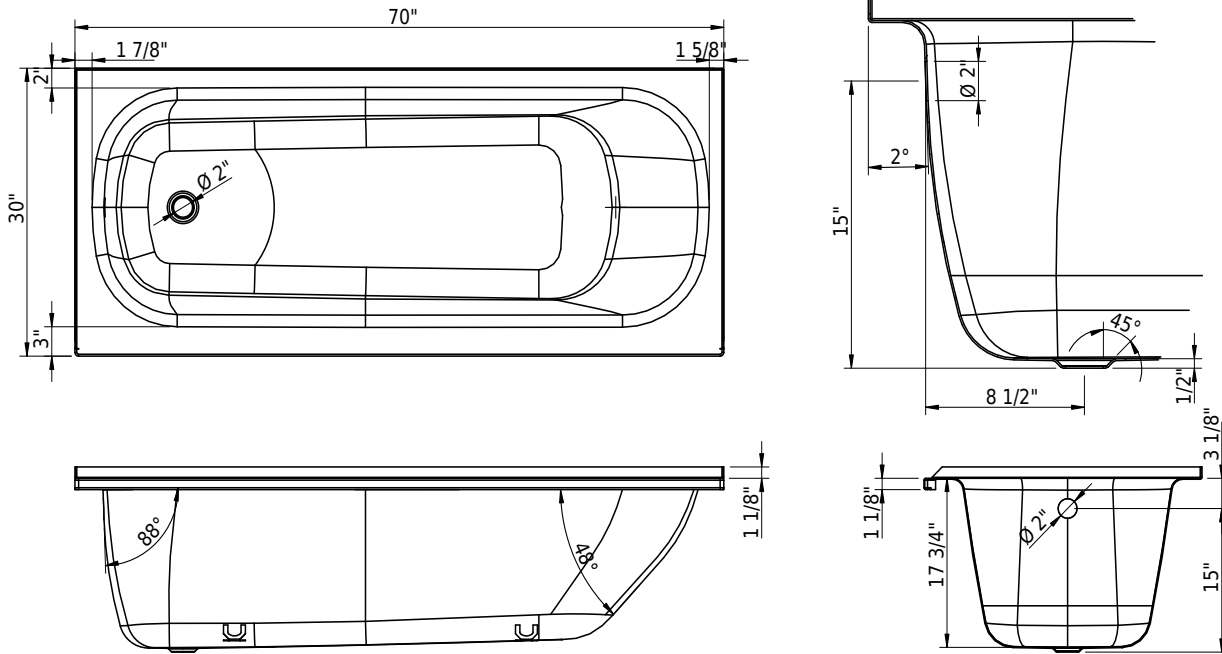

**Technical Information**

Installation location	corner
Weight without water	123 lbs
Water depth to overflow	13 3/4"
Max. water capacity to overflow	65 gal
Drain opening	2"
Overflow hole diameter	2"



➤ [Installation Instructions](#)

**Standards / Codes**

- This product complies with
- ASME A112.19.1 / CSA B45.2
- ASTM F462
- ADA

**Notes**

- Bath faucet not included
- Refer to installation instructions
- We recommend the use of Schmidlin adjustable installation feet

**Important:** Dimensions of fixtures are nominal and may vary within the range tolerances established by ANSI standard A112.19.4. These measurements are subject to change or cancellation. No responsibility is assumed for use of superseded or voided leaflet.