

Material

- Glazed titanium steel

Features

- ANTIGLISS included
- Integrated tile flanges
- Option made to measure



Compatible drain fittings

- Geberit offset, PP 150.183.00.1 (rough-in unit)
- Mountain Plumbing offset, brass BDR20SBR45/FFF (cable drive)
- OS&B direct, brass 307DQ-30FFF (clicker)
- OS&B offset, brass 314Q15-20-FFFF (clicker)
- OS&B offset, ABS 6040QK-FFF (clicker)
- OS&B offset, PVC 5150QK-FFF (clicker)
- Watco offset, brass 551/552 - NY D4
- Watco offset, brass 538 D5 (cable-drive)
- Watco offset, brass 591 EX8 D8
- Watco offset, ABS/PVC 900 EX6 D8
- Watco offset, ABS/PVC 429 D9
- Watco offset, ABS/PVC 938 D2 (cable-drive)

Variant no

Color

Tile flange

<input type="checkbox"/> 2518-0002	C1 white gloss	TF00 no tile flange
<input type="checkbox"/> 2518-0003	C1 white gloss	TF05 tile flanges on 3 sides, drain center
<input type="checkbox"/> 2518-0005	C1 white gloss	TF06 tile flanges on 2 sides, left corner
<input type="checkbox"/> 2518-0006	C1 white gloss	TF07 tile flanges on 2 sides, right corner

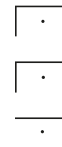

Colors

- C058 White matte
- C__ Color class III,VI



➔ color list

Accessories

Options

- CE1 CLEANEFFECT
- HS1 Handle SAFE

05/01/2026 Subject to technical changes.

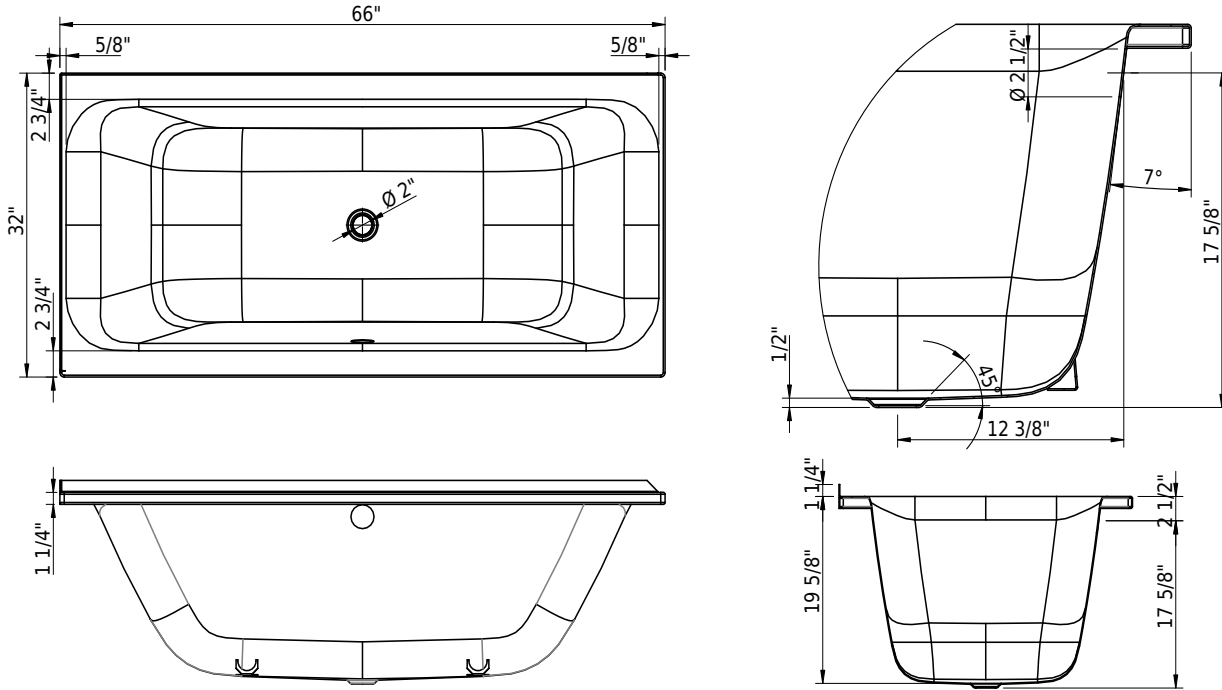

Technical Information

Installation location	corner
Weight without water	113 lbs
Water depth to overflow	15 7/8"
Max. water capacity to overflow	70 gal
Drain opening	2"
Overflow hole diameter	2 1/2"



➤ Installation Instructions

Standards / Codes

- This product complies with
- ASME A112.19.1 / CSA B45.2
- ASTM F462
- ADA

Notes

- Right hand outlet shown
- Bath faucet not included
- Refer to installation instructions
- We recommend the use of Schmidlin adjustable installation feet

Important: Dimensions of fixtures are nominal and may vary within the range tolerances established by ANSI standard A112.19.4. These measurements are subject to change or cancellation. No responsibility is assumed for use of superseded or voided leaflet.