

Material

- Glazed titanium steel

Features

- Slip resistant surface ANTIGLISS included

Compatible drain fittings

- Schmidlin, ABS, 117240
- OS&B ABS, SD35
- OS&B PVC, SD5135
- Thrifco Plumbing, ABS 124-T
- PROFLO, Brass, Stainless Steel Cover PF140NC
- Watco PVC/ABS 9300

Variant no

Color

Tile flange

<input type="checkbox"/> 2528-0002	C1 white gloss	TF00 no tile flange
<input type="checkbox"/> 2528-0003	C1 white gloss	TF05 Tile flange on 3 sides, drain center
<input type="checkbox"/> 2528-0005	C1 white gloss	TF06 Tile flanges left / back, drain center
<input type="checkbox"/> 2528-0006	C1 white gloss	TF07 Tile flanges right / back, drain right



Colors

- C058 White matte
- C__ Color class III, IV, V, VI



➔ color list

Accessories

Options

04/08/2026 Subject to technical changes.

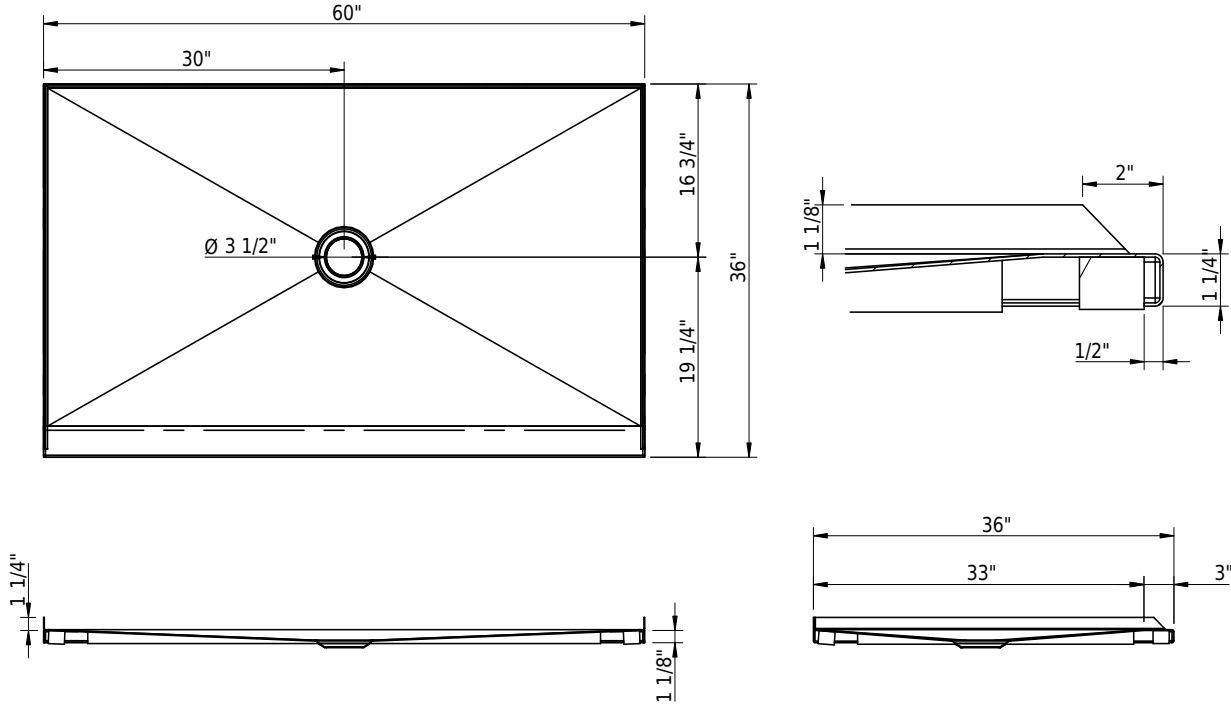

Technical Information

Installation	corner
Drain location	drain center
Weight	58 lbs
Drain opening	3 1/2"



➤ Installation Instructions

Standards / Codes

- This product complies with
- ASME A112.19.1 / CSA B45.2
- ASTM F462

Important: Dimensions of fixtures are nominal and may vary within the range tolerances established by ANSI standard A112.19.4. These measurements are subject to change or cancellation. No responsibility is assumed for use of superseded or voided leaflet.