

### Material

- Glazed titanium steel

### Features

- ANTIGLISS included
- Integrated tile flanges
- Option made to measure



### Compatible drain fittings

- Geberit offset, PP 150.183.00.1 (rough-in unit)
- Mountain Plumbing offset, brass BDR20SBR45/FFF (cable drive)
- OS&B direct, brass 307DQ-30FFF (clicker)
- OS&B offset, brass 314Q15-20-FFFF (clicker)
- OS&B offset, ABS 6040QK-FFF (clicker)
- OS&B offset, PVC 5150QK-FFF (clicker)
- Watco offset, brass 551/552 - NY D4
- Watco offset, brass 538 D5 (cable-drive)
- Watco offset, brass 591 EX8 D8
- Watco offset, ABS/PVC 900 EX6 D8
- Watco offset, ABS/PVC 429 D9
- Watco offset, ABS/PVC 938 D2 (cable-drive)

### Variant no

### Color

### Tile flange

<input type="checkbox"/> 2631-0002	C1 white gloss	TF00 no tile flange
<input type="checkbox"/> 2631-0003	C1 white gloss	TF01 Tile flange on 3 sides, drain left
<input type="checkbox"/> 2631-0004	C1 white gloss	TF02 Tile flange on 3 sides, drain right
<input type="checkbox"/> 2631-0005	C1 white gloss	TF03 Tile flanges left / back, drain left
<input type="checkbox"/> 2631-0006	C1 white gloss	TF04 Tile flanges right / back, drain right



### Colors

- C058 White matte
- C\_\_ Color class III,VI



➔ color list

### Accessories

- 109547 Schmidlin ELEMENT, magnetic candle holder
- 101188 Schmidlin RELAX Wannenkissen, schwarz, 2 Stück
- 101187 Schmidlin RELAX bathtub pillow, black, 1 piece
- 117005 Schmidlin 2-corner tape-flange, 155" (4m)
- 109810 Schmidlin adjustable installation feet (4 pieces)
- 116450 Schmidlin adjustable installation feet for Above floor Rough (4 pieces)
- 101196 Schmidlin mounting angle for tile flange (SIA 181),

### Options

- CE1 CLEANEFFEKT
- HC1 Handle CONTURA
- HS1 Handle SAFE

06/18/2026 Subject to technical changes.

HS2 Handle SAFE

4 pieces

TF\_\_ Tile flange

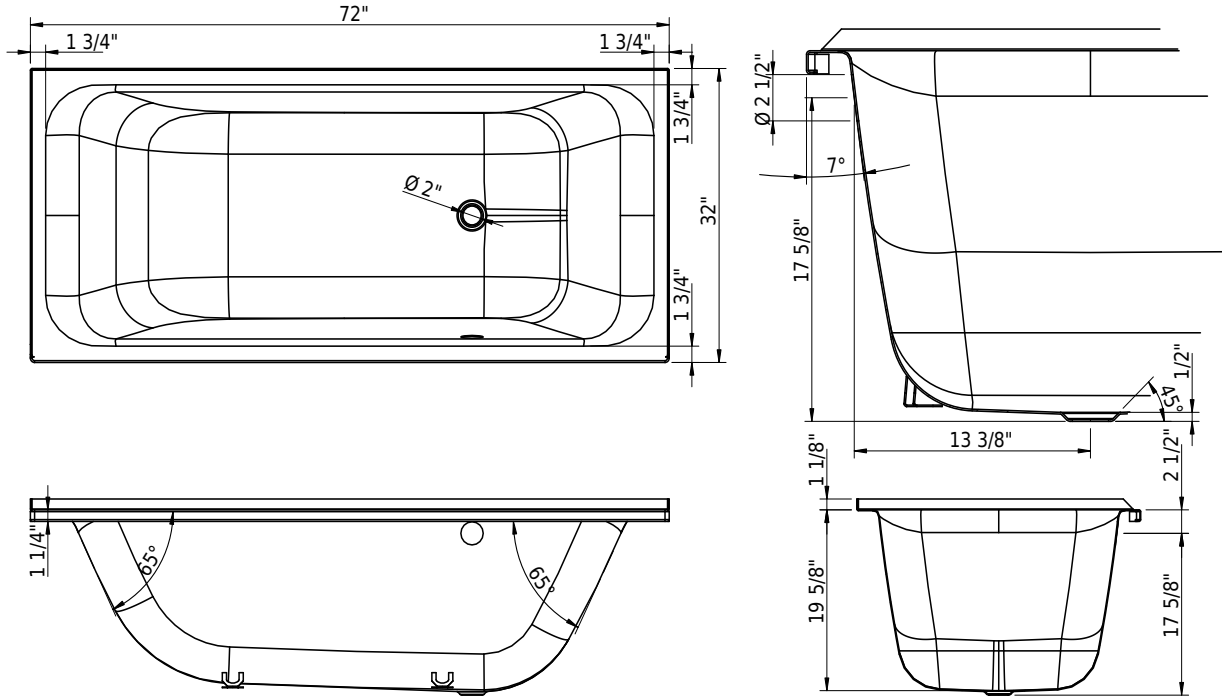

**Technical Information**

Installation location	corner
Weight without water	124 lbs
Water depth to overflow	15 7/8"
Max. water capacity to overflow	82 gal
Drain opening	2"
Overflow hole diameter	2 1/2"



➤ Installation Instructions

**Standards / Codes**

- This product complies with
- ASME A112.19.1 / CSA B45.2
- ASTM F462
- ADA

**Notes**

- Right hand outlet shown
- Bath faucet not included
- Refer to installation instructions
- We recommend the use of Schmidlin adjustable installation feet

**Important:** Dimensions of fixtures are nominal and may vary within the range tolerances established by ANSI standard A112.19.4. These measurements are subject to change or cancellation. No responsibility is assumed for use of superseded or voided leaflet.